

Item Description **e18-14-155-0915-5-105-0.22-SI-FPT-2.0-HT**  
 Model **e18.1550915105**

ECCN: EAR99 <sup>4</sup>

	Units	Lower Spec	Typical	Upper Spec
<b>Optical</b>				
CW Output Power (in fiber)	W		155	
CW Output Power (as measured)	W	134	150	
Wavelength Centroid	nm	910.0	915.0	920.0
Spectral Width (FWHM)	nm		3.9	7.0
Power within 0.15 NA	%		95	
Fiber Core / Clad Diameter	µm		105 / 125	
Fiber NA / Index Type	-		0.22 NA / Step Index	
<b>Electrical</b>				
Electrical-to-Optical Efficiency	%		44	
Threshold Current	A		0.4	
Operating Current	A		14.0	14.0
Operating Voltage	V		25.1	26.3
<b>Mechanical</b>				
Mass	g		510	
Fiber Length	m	1.5	2	
Active Fiber Bend Radius	mm	25		
Fiber Jacketing	-		900 µm Hytrel Loose Tube Buffer	
Fiber Termination	-		FPT	
<b>Thermal</b>				
Thermal Resistance	°C / W		0.3	
Waste Heat	W		196	
Operating (Housing) Temperature <sup>2,3</sup>	°C		+30	
Wavelength Temperature Coefficient	nm / °C		0.32	
Wavelength Current Coefficient	nm / A		1.1	

**Outline Drawing (Package Dimension 97 x 76 x 14 mm)**

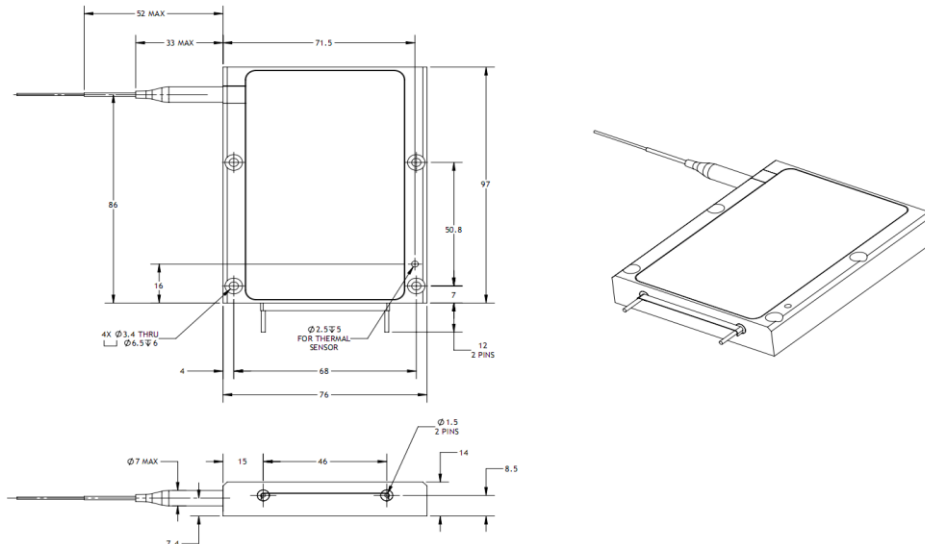

**Notes**

- <sup>1</sup> Production specification shown are for beginning of life performance. End of life operating current (Iop) is 120% beginning of life Iop.
- <sup>2</sup> A non-condensing environment is required for operation and storage. Storage conditions are from -20 to +70 °C with relative humidity between 5 to 85 %.
- <sup>3</sup> Operating temperature defined by the package housing. Acceptable operating range is 20 - 35C, but performance may vary.
- <sup>4</sup> Export Control Classification Number (ECCN) as defined by the Export Administration Regulations (EAR)

This product is not certified in accordance with IEC 60825-1 or 21CFR1040.10/ 21CFR1040.11 and is solely intended to be integrated into a laser product certified by the Purchaser. The Purchaser acknowledges that their product (incorporating the nLIGHT laser product) must comply with the applicable regulations before it can be sold.



**Notice**  
 nLIGHT continually improves its products to provide customers with outstanding quality and reliability, therefore may change certain specifications and product descriptions at any time, without notice. Additionally, nLIGHT offers a limited warranty to ensure customer satisfaction. For complete details, please contact an nLIGHT sales representative.



nLight Corporation  
 5408 NE 88th Street, Bldg E  
 Vancouver, Washington 98665  
 United States of America  
 Phone: 866.202.4488  
 360.566.4460  
 Fax: 360.546.1960  
 e-mail: sales@nlight.net  
 web: www.nlight.net