

Item Number
Item Description **940nm 200um Fiber-coupled Module**

Pilot Production Phase ²
ECCN: EAR99 ³

	Units	Lower Spec	Typical	Upper Spec
Optical				
CW Output Power	W		130	
Centroid Wavelength	nm	937	940	943
Spectral Width (FWHM)	nm			4.5
Slope Efficiency	W / A		14.9	
Beam Divergence from Fiber (90% PE)	NA		0.17	0.20
Fiber Core / Clad Diameter	µm		200 / 220	
Fiber NA / Index Type	-		0.22 / PowerCore™	
Electrical				
Electrical-to-Optical Efficiency	%	48	51	
Threshold Current	A		0.6	
Operating Current	A		9.3	10.3
Operating Voltage	V		26.2	28.8
Series Resistance	Ω		0.3	
Mechanical				
Mass ⁷	g		190	
Fiber Length	m	1.9	2.0	2.1
Fiber Bend Radius (Active / Storage)	mm		30 / 25	
Fiber Jacketing	-		Stainless Steel Squarelock	
Fiber Termination	-		SMA	
Thermal				
Thermal Resistance ⁴	°C / W		0.21	
Waste Heat	W		115	
Operating Housing Temperature ⁶	°C		+25	
Wavelength Temperature Coefficient ⁵	nm / °C		0.32	

Outline Drawing

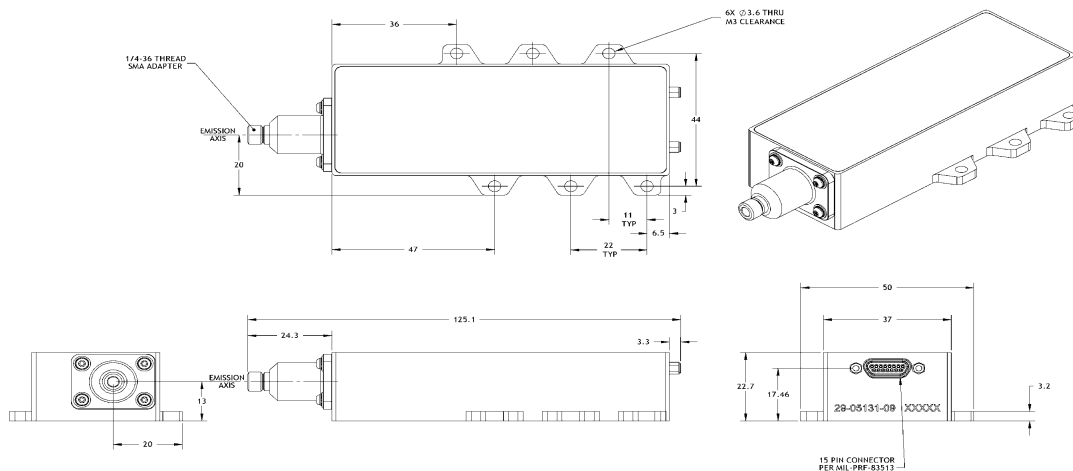

Notes

- ¹Production specifications shown are for beginning of life performance, end of life operating current (lop) is 120% beginning of life lop
- ²Current phase within nLIGHT's NPI (New Production Introduction) process
- ³Export Control Classification Number (ECCN) as defined by the Export Administration Regulations (EAR)
- ⁴Thermal resistance is the diode junction temperature shift per incremental Watt of heat load
- ⁵The wavelength temperature coefficient is the wavelength shift per °C change at the diode junction
- ⁶Operating temperature defined by the package housing. Acceptable operating range is 20 - 35C, but performance may vary
- ⁷Does not include mass of fiber

This product is not certified in accordance with IEC 60825-1 or 21CFR1040.10/21CFR1040.11 and is solely intended to be integrated into a laser product certified by the Purchaser. The Purchaser acknowledges that their product (incorporating the nLIGHT laser product) must comply with the applicable regulations before it can be sold.



Notice
nLIGHT continually improves its products to provide customers with outstanding quality and reliability, therefore may change certain specifications and product descriptions at any time, without notice. Additionally, nLIGHT offers a limited warranty to ensure customer satisfaction. For complete details, please contact an nLIGHT sales representative.



nLight Corporation
5408 NE 88th Street, Bldg E
Vancouver, Washington 98665
United States of America
Phone: 866.202.4488
360.566.4460
Fax: 360.546.1960
e-mail: sales@nlight.net
Web: www.nlight.net